

Installation Instructions

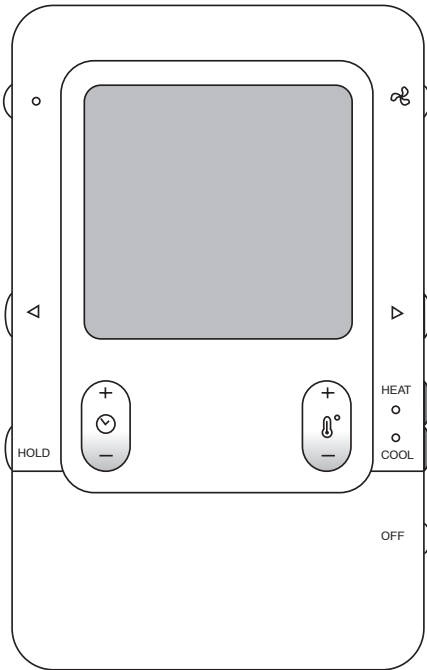

Fig. 1 - Infinity™ Control

A03149

NOTE: Read the entire instruction manual before starting the installation.

TABLE OF CONTENTS

	Page
Safety Considerations	2
Introduction	2
Installation and Start-Up Overview	2
Installation	2 - 6
Section 1 - Check Equipment & Jobsite	2
Section 2 - Infinity Control Location and Wiring Considerations	2 - 4
Section 3 - Installing Infinity Control	5 - 6
Initial Power-Up	7 - 8
Section 1 - Powerup Sequence	7
Section 2 - Selecting Outdoor Unit	7
Section 3 - Selecting Electric Heater	7
Section 4 - Selecting Accessories	7 - 8
Section 5 - Equipment Summary	8
Section 6 - Static Pressure Check	8
Quick Start	9
Install / Service Menus	10 - 15
Setup	10 - 13
Checkout	14
Service	15 - 16
Operational Information	16 - 17
Troubleshooting	18 - 19

SAFETY CONSIDERATIONS

Read and follow manufacturer instructions carefully. Follow all local electrical codes during installation. All wiring must conform to local and national electrical codes. Improper wiring or installation may damage the Infinity System. Recognize safety information. This is the safety-alert symbol . When you see this symbol on the equipment and in the instruction manual, be alert to the potential for personal injury. Understand the signal words DANGER, WARNING, and CAUTION.

These words are used with the safety-alert symbol. DANGER identifies the most serious hazards, which **will** result in severe personal injury or death. WARNING signifies a hazard, which **could** result in personal injury or death. CAUTION is used to identify unsafe practices, which **may** result in minor personal injury or product and property damage. NOTE is used to highlight suggestions which **will** result in enhanced installation, reliability, or operation.

INTRODUCTION

The Infinity System consists of several intelligent communicating components which includes the Infinity Control (or User Interface), variable speed furnace or FE fan coil, 2-stage AC or HP and Infinity Packaged Products, which continually communicate with each other via a four-wire connection called the ABCD bus. Commands, operating conditions, and other data are passed continually between components over the ABCD bus. The result is a new level of comfort, versatility, and simplicity.

All Infinity furnaces or fan coils are variable-speed and multi stage for maximum flexibility, efficiency, and comfort. They support controlled ventilation, humidification, dehumidification, and air quality control. Either an Infinity (communicating), or a standard 24 vac controlled outdoor unit may be used.

When using conventional outdoor units, the Infinity furnace or fan coil provides the 24 volt signals needed to control them. Also, the Infinity Network Interface Module (P/N SYSTXCCNIM01) allows connection of a Carrier HRV or ERV without the need for a separate wall control.

All system components are controlled through the wall mounted Infinity Control, which replaces the conventional thermostat and provides the homeowner with a single wall control for all features of the system.

INSTALLATION AND START-UP OVERVIEW

This instruction covers installation of the Infinity Control **only**. Physical installation instructions for the indoor and outdoor equipment, and accessories are provided with each unit.

Setup, commissioning, operation, and troubleshooting of the Infinity System are covered only in this installation instruction. It is the guide to connecting the system components and commissioning the system once all physical components are installed. Special screen prompts and start-up capabilities are provided in the Infinity System to simplify and automate the initial commissioning of the system.

- Install Infinity Control according to this instruction.
- Install indoor unit, outdoor unit, and accessories according to their instructions.
- Wire complete system according to this instruction.
- Setup, commission, and operate system according to this instruction to assure a smooth and trouble free start-up.

INSTALLATION

SECTION 1.—CHECK EQUIPMENT AND JOB SITE

Inspect equipment. File claim with shipping company prior to installation if shipment is damaged or incomplete.

SECTION 2.—INFINITY CONTROL LOCATION AND WIRING CONSIDERATIONS

WARNING

ELECTRICAL SHOCK HAZARD

Failure to follow this warning could result in personal injury or death.

Disconnect Power before routing control wiring.

All wiring must comply with national, local, and state codes.

INFINITY CONTROL LOCATION — The Infinity Control User Interface is the command center for the Infinity System. It should be located where it is easily accessible and visible to the adult homeowner or end user.

For accurate temperature measurement, the following guidelines should be followed:

The Infinity Control and Room Sensors should be mounted:

- Approximately 5 feet (1.5 meters) from the floor.
- Close to or in a frequently used room, preferably on an inside partitioning wall.
- On a section of wall without pipes or ductwork.

The Infinity Control and Room Sensors should **NOT** be mounted:

- Close to a window, on an outside wall, or next to a door leading to the outside.
- Exposed to direct light or heat from a lamp, sun, fireplace, or other temperature-radiating objects which could cause a false reading.
- Close to or in direct airflow from supply registers.
- In areas with poor air circulation, such as behind a door or in an alcove.

REMOTE ROOM SENSOR OPTION — A Remote Room Sensor can be used with the Infinity Control to take the place of the User Interface internal temperature sensor. This allows the Infinity Control to be mounted in areas with less than optimal airflow (such as near an exterior door, window or in a closet). The remote sensor can be wired to the terminal block connectors labeled S1 and S2 at the User Interface backplate, or the OS1 and OS1C connection at the Damper Control Module. In either case, the Infinity Control will automatically detect the Remote Room Sensor and ignore its internal temperature sensor. It is also important to note the humidity sensor cannot be remotely located, so do not locate the Infinity Control in an area where humidity sensing may not be accurate.

NOTE:S1 & S2 connection on UI backplate is now used for Remote Room Sensor, NOT for OAT Sensor hookup.

WIRING CONSIDERATIONS — Ordinary thermostat wire is recommended. Use 22 AWG or larger for normal wiring applications. Continuous wire lengths over 100 ft. should use 20 AWG or larger.

NOTE: ABCD bus wiring only requires a four-wire connection; however, it is good practice to run thermostat cable having more than four wires in the event of a damaged or broken wire during installation.

Each communicating device in the Infinity System has a four-pin connector labeled ABCD. It is recommended that the following color code be used when wiring each device:

- A — Green = Data A
- B — Yellow = Data B
- C — White = 24VAC (Com)
- D — Red = 24VAC (Hot)

It is not mandatory that the above color code be used, but each ABCD connector in the system **MUST** be wired consistently.

MOUNTING INFINITY CONTROL — There are two options for mounting the Infinity Control to the wall. First, become familiar with all plastic assembly pieces shown in Fig. 2 through 9. The User Interface will snap together with either the Recess Mount or the Surface Mount backplate.

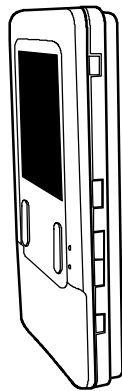

Fig. 2 - Infinity™ Control

A03185

RECESS MOUNT — This provides the thinnest mounting configuration (See Fig. 3). The backplate containing the recessed terminal block can be mounted directly to the wall by cutting a hole 1 1/2" wide by 2 1/8" high. Mark location and cut hole in wall.

NOTE: Always ensure the Infinity Control location is acceptable before cutting any holes in wall.

SURFACE MOUNT — This provides surface mounting configuration, which allows use of a small hole in the wall. A surface mount backplate is supplied (See Fig. 4). Attach backplate as shown in Fig. 7, and the assembly will mount directly to the wall requiring only a small hole in the wall allowing a four wire connection to pass through.

NOTE: Once Infinity Control is secured to wall with the backplate assembly (snapped together), care must be taken not to bend or break the interlocking tabs when removing. Gently remove Infinity Control by rocking up/down until interlocking tabs release.

DECORATIVE BACKPLATE — Supplied is a thin decorative backplate (see Fig. 5), to hide any marks/screw holes left from the previous thermostat. This decorative backplate (or beauty ring) can be used in either the recess or surface mount installation by snapping it onto back of recessed mount backplate or surface mount backplate before securing to wall. See Fig. 8 and 9 for a larger decorative backplate P/N SYSTXXOLBP01 (5.75" wide X 6" tall), which can be ordered separately.

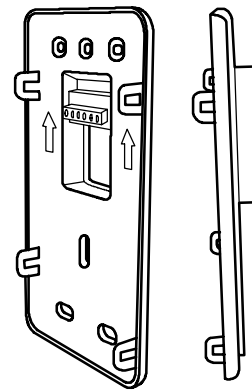

Fig. 3 - Recessed Mount Backplate

A03186

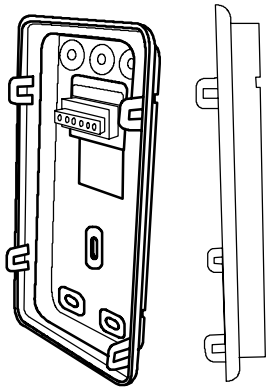

Fig. 4 - Surface Mount Backplate

A03187

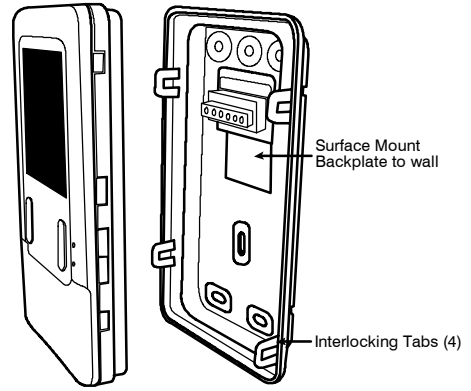

Fig. 7 - Surface Mount Assembly

A03191

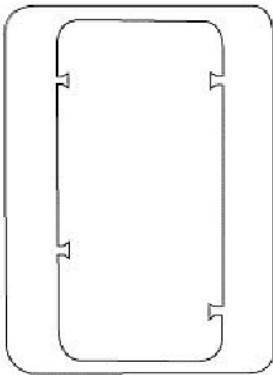

Fig. 5 - Thin Decorative Backplate

A04017

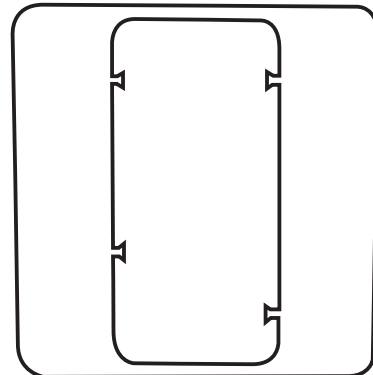

Fig. 8 - Large Decorative Backplate

A03188

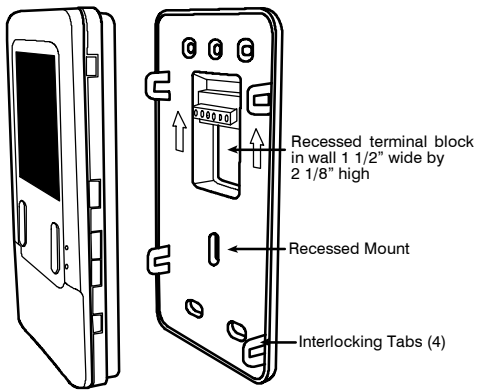

Fig. 6 - Recessed Mount Assembly

A03190

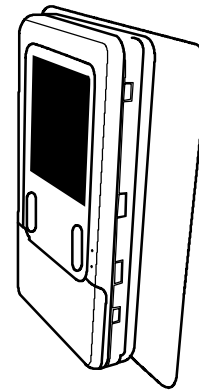

Fig. 9 - Decorative Backplate Assembly

A03192

⚠ WARNING

ELECTRICAL SHOCK HAZARD

Failure to follow this warning could result in personal injury or death.

Before installing Infinity Control, turn off all power to equipment. There may be more than one power source to disconnect.

⚠ CAUTION

ELECTRICAL OPERATION HAZARD

Failure to follow this caution may result in equipment damage or improper operation.

Improper wiring of the ABCD connector will cause the Infinity System to operate improperly. Check to make sure all wiring is correct before proceeding with installation or turning on power.

2. Turn off all power to equipment.
3. If an existing User Interface or control is being replaced:
 - d. Remove existing control from wall.
 - e. Disconnect wires from existing control.
 - f. Discard or recycle old control.

NOTE: Mercury is a hazardous waste, if existing control contains any mercury, it **MUST** be disposed of properly. The User Interface does not contain mercury.

4. Select Infinity Control mounting plastic (recess mount or surface mount and decorative backplate if desired).
5. Route wires through large hole in mounting plastic. Level rear plastic against wall (for aesthetic value only - Infinity Control need not be level to operate properly) and mark wall through two mounting holes.
6. Drill two 3/16 inch mounting holes in wall where marked.
7. Secure mounting plastic to wall using two screws and anchors provided.
8. Adjust length and routing of each wire to reach each wire entry on the connector backplate. Strip 1/2 inch of insulation from each wire.
9. Match and connect thermostat wires to proper terminals on User Interface backplate. See wiring diagram Fig. 11, 12, and 13.

- A — Green = Data A
- B — Yellow = Data B
- C — White = 24VAC (Com)
- D — Red = 24VAC (Hot)

NOTE: It is not mandatory that the above color code be used, but each ABCD connection in the system **MUST** be wired consistently. A separate ABCD Connector comes inside packaging and should be used when connecting to furnace (or fan coil). Ensure connector is inserted properly into circuit board. (See Fig. 10)

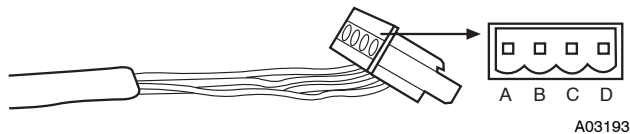

Fig. 10 - Wire ABCD Connector

10. Push any excess wire into the wall. Seal hole in wall to prevent any air leaks. Leaks can affect operation.
11. Attach Infinity Control to the mounting plastic by lining up the plastic guides on the back of the control with the opening on the mounting plastic and push on.
12. Perform installation of all other system equipment (i.e. dampers, humidifier, ventilator, UV lights, etc.)
13. Turn on power to equipment.

See wiring diagram Fig. 11 which includes an indoor communicating furnace or FE fan coil, with a communicating outdoor unit. No additional OAT (outdoor air temperature) sensor is required because the Infinity Control will use the temperature sensor inside the outdoor unit.

See wiring diagram Fig. 12 for connecting an indoor communicating furnace or FE fan coil with a 1-stage air conditioning unit (non-communicating outdoor). An Outdoor Air Temperature (OAT) sensor may be installed (but is not required) at the indoor furnace or fan coil OAT terminals. When OAT sensor is applied, the Infinity System will provide enhanced system features and benefits.

See wiring diagram Fig. 13 for connecting an FE fan coil with a 1-stage heat pump (non-communicating outdoor unit). When OAT is applied, the Infinity system will provide enhanced system features and benefits.

NOTE: For other applications not listed, refer to the Network Interface Module (NIM) Installation Instructions.

SYSTXCCUID01-A

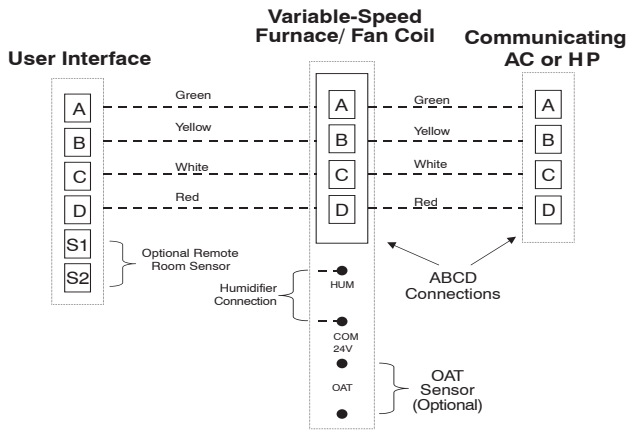

A03146

Fig. 11 - Universal Four-Wire Connection Diagram

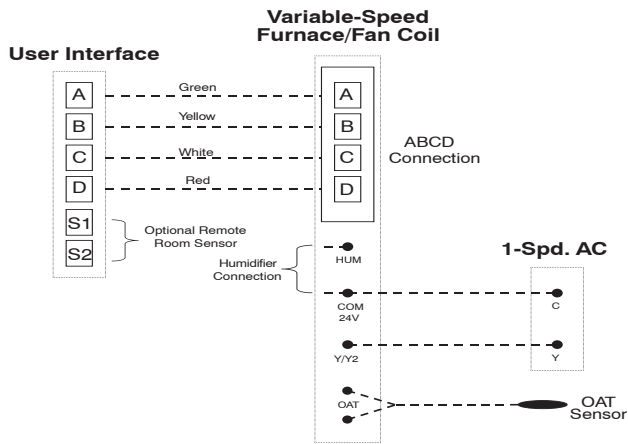

A03147

Fig. 12 - Connection Diagram for Furnace or FE Fan Coil w/1-Stage AC

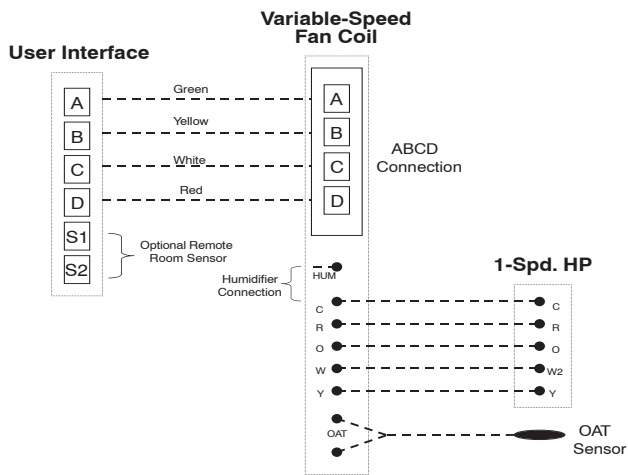

A03148

Fig. 13 - Connection Diagram for FE Fan Coil with Non-Communicating 1-stage HP

HUMIDIFIER CONNECTION — A 24vac bypass or fan powered humidifier may be installed.

NOTE: Do Not Use a traditional humidistat to control humidifier operation. If a humidifier is installed, let the Infinity Control operate humidifier.

BYPASS HUMIDIFIERS — A bypass humidifier should be wired directly to the furnace or fan coil HUM and 24vac COM terminals. The Infinity Control will automatically energize the HUM output during a call for humidification.

FAN POWERED HUMIDIFIERS — Most fan powered humidifiers produce internal 24vac in order to energize upon a switch or contact closure. For this application, a 24vac N.O. Isolation Relay (DPST) **MUST** be used to prevent mixing the internal humidifier power with the indoor equipment transformer. Applying 24vac isolation relay coil to furnace or fan coil HUM and COM terminals will allow the Infinity Control to automatically energize the HUM output during a call for humidification. The N.O. relay contacts will be used to energize the humidifier. See fan powered humidifier installation instructions for more details.

⚠ CAUTION

EQUIPMENT HAZARD

Failure to follow this caution may result in equipment damage. Do not apply 24vac fan powered humidifier (with internal power supply) direct to indoor unit HUM and COM terminals.

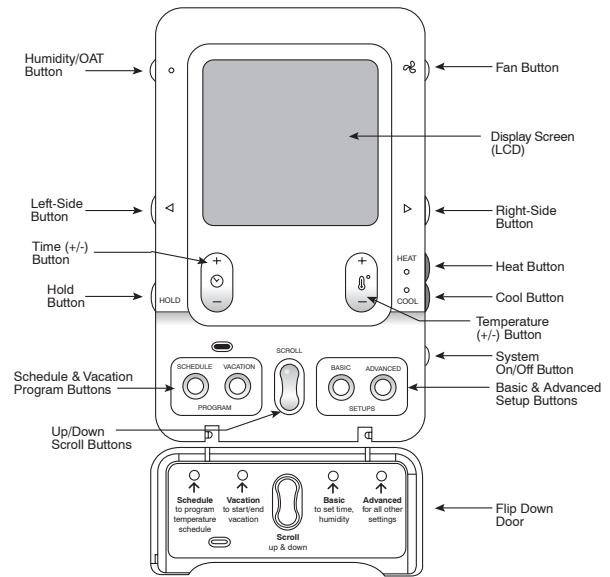

A03194

Fig. 14 - Functional Overview

INITIAL POWER-UP

NOTE: Refer to Functional Overview (Fig. 14) to become familiar with key function buttons such as “System On/Off,” “Fan,” “Left-Side” and “Right-Side” buttons, etc. These function buttons will be used frequently during setup.

SECTION 1.—POWER UP SEQUENCE



A03195

Fig. 15 - Power Up Sequence

This section addresses initial power up (or commissioning) of a new Infinity Control. The User Interface will communicate and identify all Infinity components in the system. The following is a typical example for a communicating Variable-Speed Furnace / Fan Coil with a 2-stage Air Conditioner / Heat Pump (including Dual Fuel).

The User Interface display will light up and indicate that it is now “ESTABLISHING COMMUNICATIONS WITH EQUIPMENT PLEASE WAIT.” The User Interface will automatically continue by “SEARCHING FOR EQUIPMENT“, followed by “SEARCHING FOR OUTDOOR EQUIPMENT” (See Fig. 15). Once the indoor and outdoor equipment has been found, the Installer will be asked to select Accessories. Packaged Products will be automatically identified and the Installer will be asked to select Accessories. Proceed to SECTION 4 — SELECTING ACCESSORIES.

NOTE: If the variable-speed indoor equipment (furnace or fan coil) cannot be found, the User Interface will display “CANNOT COMMUNICATE WITH INDOOR UNIT.” This MUST be corrected before the initial power up sequence can continue. If indoor unit is found, but outdoor unit is not found, “OUTDOOR UNIT NOT IDENTIFIED“ will appear. Proceed to the next section for Outdoor Unit Identification.

SECTION 2.—SELECTING OUTDOOR UNIT

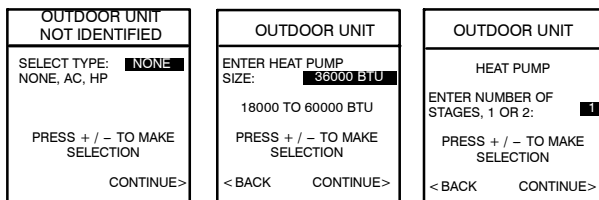

A03196

Fig. 16 - Selecting Outdoor Unit

If there is no communicating outdoor unit, the screen, shown in Fig. 16, will appear. Press either Time or Temp +/- buttons to select AC (air conditioner), HP (heat pump), or None (no unit installed). Press right-side button to continue to next screen.

If either AC or HP has been selected as the outdoor unit type, the middle screen will appear (See Fig. 16). Press either Time or Temp +/- buttons to select appropriate Btu size of outdoor unit, then press right side button to continue. If a NIM (Network Interface Module) is applied for non-communicating two-stage outdoor equipment, select 1 or 2-stage compressor operation, and press right-side button to continue.

NOTE: Range of outdoor unit Btu selection is limited by model number of indoor unit installed. The Infinity Control will not

allow an outdoor unit size that is not supported by the installed indoor unit.

NOTE: On new system installations, the model and serial number will be recognized and displayed. On any indoor/outdoor board replacements, the equipment will be recognized but the exact model/serial number will not be displayed.

SECTION 3.—SELECTING ELECTRIC HEATER

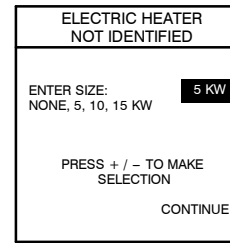

A03197

Fig. 17 - Selecting Electric Heater

If the equipment is a fan coil, packaged heat pump, or packaged AC and the electric heater is not self-identifying, “ELECTRIC HEATER NOT IDENTIFIED” will appear (See Fig. 17). Press either Time or Temp +/- buttons to select appropriate size of electric heater installed, then press right-side button to continue. An asterisks (*) will appear next to electric heater sizes that may cause excessive airflow.

NOTE: Range of electric heaters available is limited by model number of the equipment installed. The Infinity Control will not allow an electric heater size that is not supported by the installed equipment.

SECTION 4.—SELECTING ACCESSORIES

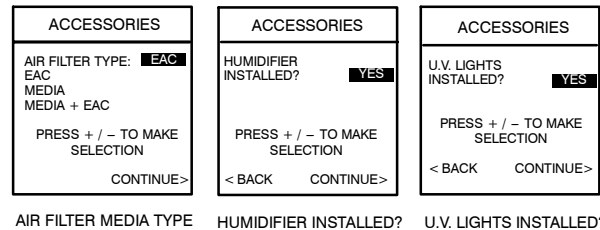

AIR FILTER MEDIA TYPE

HUMIDIFIER INSTALLED?

U.V. LIGHTS INSTALLED?

A03198

Fig. 18 - Accessories —UV Lights

Once the indoor and outdoor equipment have been found or entered, the following screens will appear allowing the Installer to select the “AIR FILTER TYPE; HUMIDIFIER INSTALLED; and UV LIGHTS INSTALLED“ (See Fig. 18). Use either Time or Temp +/- buttons to make appropriate selections in the highlighted area on the display screen. Press right-side button to continue (or advance) to the next screen.

AIR FILTER TYPE — This accessory screen will appear first. The installer will need to enter the type of filter (MEDIA, EAC, or both). See Table 1 and make a selection using Time or Temp +/- button, then press right-side button to continue.

Table 5—Filter Selection

INSTALLED FILTER	MENU SELECTION
1 inch to 4 inch media	MEDIA
High voltage EAC	EAC
High voltage EAC + 1 to 4 inch media	MEDIA + EAC

HUMIDIFIER INSTALLED — This will appear after the Air Filter Type screen. Select whether a humidifier is installed on the system, YES or NO, then press right-side button to continue.

UV LIGHTS INSTALLED — This screen will appear to select whether UV lights are installed on the system, select YES or NO, then press right-side button to continue.

SECTION 5.—EQUIPMENT SUMMARY

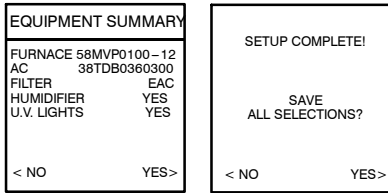

Fig. 19 - Equipment Summary

A04046

The “EQUIPMENT SUMMARY“ screen will appear after Accessories have been selected. This screen will give a summary of all equipment automatically found or manually selected. If a wrong selection was made, press left-side button (BACK selection) to go back to that particular screen and make changes. When everything is OK, press right-side button again to continue. (See Fig. 19)

The “SETUP COMPLETE! SAVE ALL SELECTIONS?“ screen will appear after Equipment Summary. To Save All Selections press (YES) right-side button. Pressing the left-side button (NO selection) will return to the Equipment Summary screen where changes can be performed to any of the equipment selection screens. After selecting YES, the initial power up sequence of the new Infinity Control is complete.

SECTION 6.—STATIC PRESSURE CHECK

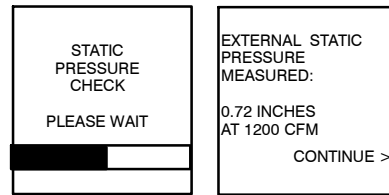

Fig. 20 - STATIC PRESSURE CHECK

A05000

This screen will appear after Setup is exited. The system will open all dampers and perform a static pressure check. This process will take about 1 1/2 minutes to complete. When completed, a screen will appear displaying the static pressure (in inches) across the equipment at the expected highest delivered airflow. If the static pressure is over 1 inch, a warning will appear, but equipment operation and the TrueSense™ dirty filter detection operation will not be affected.

NOTE: The static pressure check occurs only at initial installation, or when INSTALL is run in the INSTALL/SERVICE menu.

QUICK START

For first time installers, Quick Start will allow a quick start up of the Infinity System before learning all the details of system operation. However, for the best possible comfort and operation refer to the Infinity Control Owner's Manual.

SET DAY, TIME & DESIRED HUMIDITY

1. Flip down the door at the base of the Infinity Control and press the **BASIC** button.
2. Adjust the highlighted **HOUR** setting using the **TIME (+/-)** button.
3. Press **SCROLL** button (down) to highlight **MINUTE**.
4. Adjust the **MINUTE** setting using the **TIME (+/-)** button.
5. Press **SCROLL** button (down) to highlight **DAY**.
6. Adjust the current **DAY** setting using the **TIME (+/-)** button.
7. Press **SCROLL** button (down) to highlight **HUMIDITY**.
8. Press the red **HEAT** button to select heating humidity.
9. Adjust desired heating humidity level using either (+/-) button.
10. Press the blue **COOL** button to select cooling humidity.
11. Adjust the desired cooling humidity level using either (+/-) button.
12. To exit press **BASIC** button or close door.
13. If changes are made, you will be asked to "**SAVE CHANGES? YES/NO.**"

OVERRIDE HEATING SCHEDULE

1. Press the red **HEAT** button. Heating mode is confirmed when the red LED next to the red **HEAT** button is lit.
2. Use the **TEMP (+/-)** button to select your desired heating temperature.
3. The default time for temporarily overriding the temperature schedule is 2:00 HRS as indicated by the text on the lower left.

NOTE: Override time will not appear if programming has been turned off.

4. You can change the temporary override time in 15-minute increments by pressing the **TIME (+/-)** button until the desired override time is selected, or press the **HOLD** button anytime to override the schedule indefinitely.

QUICK PROGRAM SCHEDULE FOR ALL DAYS

This section will give you a quick program schedule for **ALL DAYS** of the week. For more information on how to create customized schedules for every day, the entire week, or weekend, refer to the Owner's Manual.

1. Flip down the door at the bottom of the control.
2. Press the **SCHEDULE** button, which allows you to create one schedule for the entire home.
3. Press either the **LEFT** or **RIGHT** side button repeatedly (if necessary) until "**ALLDAYS**" is displayed. The **WAKE** time period will be highlighted.
4. Using the **TIME (+/-)** button, set the start time for this time period.
5. Press the red **HEAT** button. Heating temperature will begin flashing.
6. Set the heating temperature using the **TEMP (+/-)** button.
7. Press the blue **COOL** button. Cooling temperature will begin flashing.
8. Set the cooling temperature using the **TEMP (+/-)** button.
9. Set the remaining periods by using the **SCROLL** button to select "**DAY**," "**EVENING**," and "**SLEEP**".
10. Exit the scheduling mode by either closing the door or pressing the **SCHEDULE** button.
11. If changes are made, you will be asked to "**SAVE CHANGES YES/NO.**"

INSTALL / SERVICE MENUS

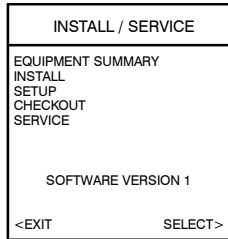

Fig. 21 - INSTALL / SERVICE MENUS

A03200

The "INSTALL / SERVICE" menus contain a set of vital information. This information enables the Installer or Service person to view a summary of what has been installed, etc. This information is not covered in the Owner's Manual.

To enter **INSTALL / SERVICE** menus, press and hold the **ADVANCED** button for at least ten seconds. The following menu will appear (See Fig. 21):

NOTE: The **INSTALL / SERVICE** menu will automatically exit after 60 minutes of no push button activity.

EQUIPMENT SUMMARY: Shows all equipment recognized by and attached to the system.

INSTALL: Used when adding, changing out, or uninstalling equipment.

SETUP: Used to view or modify equipment settings.

CHECKOUT: Allows testing of equipment operation

SERVICE: Used to view operation and fault history of equipment and enter dealer name/phone number for display

EQUIPMENT SUMMARY MENU

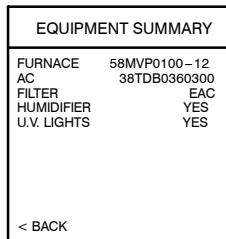

Fig. 22 - EQUIPMENT SUMMARY

A03201

This screen shows indoor unit type and model number, outdoor unit type (and model number if a 2-stage unit), filter type and any accessories that are installed are recognized.

INSTALL MENU

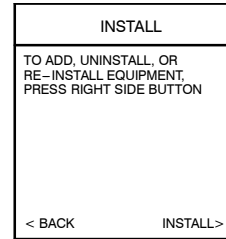

Fig. 23 - INSTALL

A03202

This menu item will perform start-up process in order to learn all equipment in system. Press right side button to initiate the process. See Fig. 23.

SETUP MENU

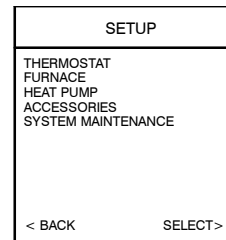

Fig. 24 - SETUP MENU

A03203

This menu has several layers, allowing modification of equipment settings. No settings will need to be made at equipment (i.e. DIP switches on a furnace). All configuration settings made effective from this menu will override equipment configuration made by dip switches. Fig. 24 shows all the information that can be found in the **SETUP** menu.

SETUP — THERMOSTAT

AUTO MODE SETUP:

- Enable/Disable Auto Changeover mode (default=Enable).
- Auto Changeover Time may be adjusted 5 to 120 minutes, (default = 30 minutes).

When Auto mode is enabled (factory default) a change from heat to cool (or vice versa) will not occur until an opposite mode demand has existed for 30 minutes. If the set point is changed, the 30 minute timer is deleted.

HEAT/COOL DEADBAND:

- 0 to 6 degrees, (default = 2°).

A minimum difference of 2° is enforced between heating and cooling desired temperatures. This will allow one setting to "push" the other to maintain this difference.

OFFSETS:

This option allows calibration (or deliberate miscalibration) of the temperature and humidity sensors. These offsets are added to the actual temperature/humidity values (defaults=0).

- Zone 1 Offset: -5 to +5 degrees.
- Outside Temp Offset: -5 to +5 degrees.
- Humidity Offset: -10 to +10 percent.

CYCLES PER HOUR:

- Maximum cycles per hour = 4 (default) or 6.
- Anticipator = 1 to 9 (default=3). This adjusts sensitivity to temperature changes. 1 = most sensitive, 9 = least sensitive.
- If space is over-conditioning, increase the anticipator setting.
- If space is under-conditioning, decrease the anticipator setting.

PROGRAMMING:

- ON (default)- allows program schedule to be set by user.
- OFF - system becomes non-programmable
- Periods Per Day = 2 or 4 (default=4)
- Programmable Fan On/Off (default=Off). If ON is selected, fan can be set to Auto, Low, Med, or High.

SMART RECOVERY:

- On or Off, (default=On)

Applies to programmable operation only. Will start recovery 90 minutes prior to schedule change in both heating and cooling mode. Refer to operational information for more detail.

ENGLISH/METRIC DISPLAY

- °F or °C, (default = °F)

RESET FACTORY DEFAULTS:

Program Schedule:

- Yes/No to reset back to Energy Star default Time and Temp schedules.

User Settings:

- Yes/No to reset the user settings in the Advanced Setup to factory default settings.

Install Settings:

- Yes/No to reset install settings in Install/Service menus to factory default settings.

Last 10 Faults:

- Yes/No to reset last 10 faults under Service Info menu.

SETUP — FURNACE

Upon a first time start-up of the Infinity Control, the furnace DIP switch settings will be copied to the furnace setup menu. Any changes can then be made from the Infinity Control.

AIRFLOW:

- COMFORT (default)
- EFFICIENCY

Selects the airflow of the furnace when heating. **EFFICIENCY** is the airflow used to meet specified ratings, **COMFORT** is a decreased airflow used to increase the output air temperature and provide increased comfort.

AC AIRFLOW

- COMFORT (default) - cooling airflow is varied depending on humidity and temperature demands settings. This selection enables the full dehumidify and comfort capabilities of the system. When COMFORT is not selected, the unit will not run reduced airflows for dehumidification.
- EFFICIENCY - fixed airflow used to achieve specified ratings - no dehumidification airflow reduction. This is nominally 350 CFM/ton, but will vary if a 2-stage outdoor unit is used.
- MAXIMUM - 400 CFM/ton. Dehumidify features are not active when set to maximum.

DEHUM AIRFLOW

- NORMAL (factory default) - When equipment is running to dehumidify, the airflow is allowed to adjust to a minimum to satisfy the dehumidification call.
- HIGH - Minimum airflow during the dehumidify mode is increased to reduce duct and register sweating.

LOW HEAT RISE

- ON
- OFF (default)

Set to **ON** if the system contains a bypass humidifier. The **ON** setting will increase the furnace low heat airflow.

STAGING

- SYSTEM (default)
- LOW
- HIGH
- FURNACE

Controls the staging of the furnace. **SYSTEM** setting will allow the Infinity Control to determine furnace staging. **LOW** will only run the low stage of furnace heat. **HIGH** will only run the high stage of furnace heat. **FURNACE** will allow the furnace algorithm to control staging

OFF DELAY:

- 90 seconds
- 120 seconds (default)
- 150 seconds
- 180 seconds

Amount of time the blower will continue to run after heating has shut off.

LOCKOUT TEMP:

- NONE (default)
- +5 to 55 deg F

Appears on **dual fuel** systems only (furnace with heat pump). Outside temperature above which the furnace will **NOT** run except for defrost. During heat pump defrost cycle, the furnace will operate above the furnace lockout temperature. Once in defrost, the system will satisfy the heating demand with the gas furnace.

SETUP — FAN COIL

HP/AC AIRFLOW:

- **COMFORT** (default) Cooling airflow is varied depending on humidity and temperature demand settings. This selection enables the full dehumidify and comfort capabilities of the system. When **COMFORT** is not selected, the unit will not run reduced airflows for dehumidification. Heat Pump airflow is varied depending on outdoor temperature to maximize comfort.
- **EFFICIENCY** - fixed airflow used to achieve specified ratings - no dehumidification airflow reduction. This is nominally 350 CFM/ton, but will vary if a 2-stage outdoor unit is used.
- **MAXIMUM** - 400 CFM/ton. Dehumidify features are not active when set to maximum.

DEHUM AIRFLOW:

- **NORMAL** (factory default) - When equipment is running to dehumidify, the airflow is allowed to adjust to a minimum to satisfy the dehumidification call.
- **HIGH** - Minimum airflow during the dehumidify mode is increased to reduce duct and register sweating.

HEATER SIZE:

- (choices dependent upon fan coil model)

This will show the heater size entered during the start-up process. This value can be changed to another value (limited by the model number of the fan coil). If the electric heater is self-identifying, this value is not shown.

SETUP — HEAT PUMP / AC

COOLING LOCKOUT:

- NONE (default)
- 45° F.
- 50° F.
- 55° F.

Outside temperature below which cooling will not be provided.

LOW AMBIENT COOLING:

- NO (default)
- YES

Selecting **YES** will enable the low ambient cooling operation in the outdoor unit. This setting is only available with communicating outdoor units and with Cooling Lockout set to **NONE**.

ENTERED SIZE:

- (dependent on indoor unit model)

Size of the outdoor unit entered during the start-up process. If the outdoor unit is a communicating model, this value will not be shown. This size can be changed here but is limited to sizes that the indoor unit can handle.

DEFROST INTERVAL:

- 30 minutes
- 60 minutes
- 90 minutes
- 120 minutes (default)
- Auto-Defrost interval optimized by outdoor control (default for communicating HP)

Time interval at which defrost cycles can occur on a heat pump.

ELECT HEAT LOCKOUT

- NONE (default)
- +5 to 55 deg. F

Outside temperature above which the electric heat will not operate

HEAT PUMP LOCKOUT (BALANCE POINT TEMP):

In a dual fuel system this option will be available in place of Electric Heat Lockout Temp.

This is the outdoor temperature below which the heat pump will not operate.

HIGH COOL LATCH:

- NONE (default)
- 80 - 110 deg F

Outside temperature above which only the high speed (of a 2-stage outdoor unit) will run when cooling.

HIGH HEAT LATCH

- OFF (default)
- ON 2 -stage heat pump runs only high stage heating

SETUP — ACCESSORIES

FILTER TYPE:

- MEDIA (i.e. TrueSense™)
- EAC
- MEDIA+EAC (i.e. TrueSense™)

CLEAN INTERVAL: 30 to 180 days (of actual blower operation). (Default = 90)

Interval at which the Clean Filter notification will turn on. Applies to EAC filter selection only.

HUMIDIFIER INSTALLED:

- NO
- YES

If YES, indicates to the system whether a humidifier is installed and enables humidification functions.

CHANGE PAD INTERVAL: 1 to 24 months (default=12 months)

Interval at which the Change Humidify Pad notification will be displayed.

HUMIDIFY WITH FAN:

- NO (default)
- YES

If YES, the humidifier will turn on if there is a humidify demand present. The fan will turn on to Low speed if the fan setting is Auto.

VENTILATOR:

NOTE: Only appears if ventilator is installed.

CLEAN INTERVAL:

- 60 to 180 days of actual operation (default=90)

Interval at which the Clean Ventilator Pre-filter notification will turn on.

UV LIGHTS INSTALLED:

- NO
- YES

If YES, indicates to the system whether UV lights are installed.

CHANGE INTERVAL:

- 6 to 48 months operation time (default=12 months)

Interval at which the Change UV Lights notification will be displayed.

SETUP — SYSTEM MAINTENANCE

REMIND OWNER OF ROUTINE MAINTENANCE EVERY:

This setup is used to adjust the timer interval in which the normal System Maintenance notification is turned on for the homeowner.

Range =

- OFF
- 6 to 24 months, (default=12 months)

SETUP — UTILITY SAVER

COOLING:

- Turn off, Low Stage

This setup is available only if the equipment has a utility saver input (refer to equipment Installation Instructions.) This setup controls the response of the equipment when the utility saver input is active.

The choices include:

- Turn Off, (equipment turns off)
- Low Stage (available if the AC/heat pump is a 2-stage model, runs low speed only)

CHECKOUT MENUS

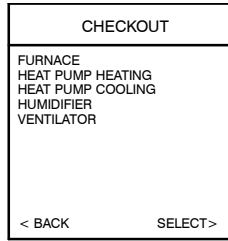

Fig. 25 - CHECKOUT MENU

A03204

The Checkout menu will show the equipment installed in the system. A sample checkout menu is shown in Fig. 25.

CHECKOUT — FURNACE OR GAS PAC

Make sure the furnace is properly installed before continuing.

- LOW HEAT RUNTIME: 5 min.
- HIGH HEAT RUNTIME: 5 min.

This menu item allows the furnace to be exercised. First, a low heat runtime and high heat runtime are selected. Range = 5 - 120 min.

If only the low heat is to be exercised:

The furnace will execute its ignition start-up sequence. This sequence will be displayed on the Infinity Control screen. After the gas valve and blower motor turn on, the screen will automatically change to "FURNACE CHECK" and show the current operating status of the furnace.

CHECKOUT—ELECTRIC HEAT

- ELECTRIC HEAT RUNTIME: 5 min., Default time = 5 min., Range = 0 - 120 min.

If you have a fan coil with electric heaters, this menu item will allow the heaters to be exercised.

With self-identifying electric heaters, three stages of electric heat are available to be exercised in any combination. Non-identifying heaters will only provide one stage of heat.

Enter the run time (in minutes) of each stage of heat to be exercised then press START (right-side button). The display will change to show the fan coil's operating status.

CHECKOUT — HEAT PUMP HEATING

- HIGH HEAT RUNTIME: 5 min.
- LOW HEAT RUNTIME: 5 min.
- DEFROST: NO

The heat pump heating mode can be exercised with this menu option. With a 2-stage heat pump, a low heat runtime and a high heat runtime are independently selectable to exercise. A defrost cycle is also selectable. Default time = Fixed 5 min. minimum, range = 5 - 120 min.

NOTE: Airflows during Checkout modes are fixed to the Efficiency setting and are independent of other airflow settings. To view airflows for normal heat pump heating mode, exit the Checkout screen and apply a heating demand to the system.

CHECKOUT — HEAT PUMP COOLING OR AC COOLING

- HIGH COOL RUNTIME: 5 min.
- LOW COOL RUNTIME: 5 min.

The heat pump cooling mode (or AC cooling mode) can be exercised with this menu option. With a 2-stage heat pump or AC unit, a low cool runtime and a high cool runtime are independently selectable to exercise. The display will change to show the heat pump or AC operating status.

Default time = Fixed 5 min. minimum, range = 5 - 120 min.

NOTE: Airflows during Checkout modes are fixed to the Efficiency setting and are independent of other airflow settings. To view airflows for normal heat pump heating mode, exit the Checkout screen and apply a heating demand to the system.

CHECKOUT — HUMIDIFIER

- OFF
- ON

The humidifier can be exercised On and Off with this menu option.

CHECKOUT — VENTILATOR

SPEED:

- OFF
- LOW
- HIGH

The ventilator can be exercised through all of its operating speeds with this menu option.

CHECKOUT — SYSTEM ACCESS MODULE (SAM)

RADIO CHECK:

This will perform a radio check of the SAM. Three messages will be sent and received and can take up to 15 minutes to complete.

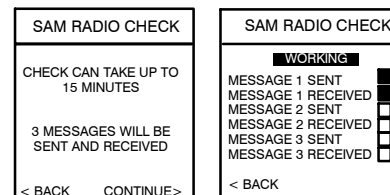

Fig. 26 - SAM RADIO CHECK MENU

A04092

PROFILE UPDATE:

This will update the computer servers with the current equipment configuration. If equipment changes, performing a Profile Update will ensure the server has the latest system information.

SERVICE MENUS

The Service Info menu will only show the equipment installed in the system. Below is a sample using a furnace and a heat pump (dual fuel). A sample service menu is shown in Fig. 27.

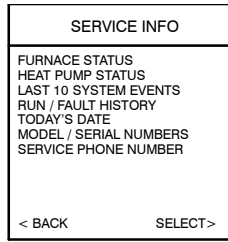

Fig. 27 - SERVICE INFO MENU

A03205

SERVICE — FURNACE STATUS OR GAS PAC STATUS

The Status screens will show all of the current operating parameters of each installed piece of equipment.

HEAT STAGE:

- OFF, LOW, HIGH

Displays stage of heat that the furnace is currently delivering.

AIRFLOW CFM:

- (furnace model dependent)

Cubic Feet per Minute of air the blower is currently delivering.

LEAVING AIR TEMP:

This sensor is NOT required. However, if LAT sensor is connected to the Damper Control Module, the sensor will read leaving air temperature of the furnace.

INDOOR COIL TEMP:

This sensor is NOT required. However, if HPT sensor is connected to the Damper Control Module, the sensor will read temperature at that location (i.e. if placed in return-air, will read return-air temperature).

INDUCER RPM (90% FURNACES ONLY):

- Inducer motor RPM value.

BLOWER RPM:

- Blower motor RPM value.

STATIC PRESS:

- Inches of water. Displays static pressure that the furnace is currently experiencing.

LOCKOUT TIMER:

- Seconds

If a lockout timer is active, this will show the current time value. See furnace manual for details on lockout timers.

SERVICE — FAN COIL STATUS

ELECTRIC HEAT:

- OFF, LOW, MED, HIGH

Displays stages of electric heat that the fan coil is currently delivering.

AIRFLOW CFM:

- (fan coil model number dependent)

Cubic Feet per Minute of air the blower is currently delivering.

LEAVING AIR TEMP:

This sensor is NOT required. However, if LAT sensor is connected to the Damper Control Module, the sensor will read leaving air temperature of the fan coil.

INDOOR COIL TEMP:

This sensor is NOT required. However, if HPT sensor is connected to the Damper Control Module, the sensor will read temperature at that location (i.e. if placed down stream from evaporator coil, and before electric heat, will read coil leaving air temperature).

BLOWER RPM:

- Blower motor RPM value

STATIC PRESS:

- Inches of water

Displays static pressure that the fan coil is currently experiencing.

SERVICE — HEAT PUMP / AC STATUS

STAGE: (HEAT / COOL):

- OFF, LOW, HIGH

Displays stage of heating or cooling that the Heat Pump/AC is delivering.

DEFROST:

- NO, YES

Displays status of defrost mode if heat pump.

AIRFLOW CFM:

- Indoor unit CFM measurement.

LEAVING AIR TEMP:

This sensor is NOT required. However, if LAT sensor is connected to the Damper Control Module, sensor will read leaving air temperature of the indoor unit.

OUTDOOR COIL TEMP:

- Degrees F.

Temperature of the outdoor unit coil (only available on 2-stage communicating outdoor units).

BLOWER RPM:

- RPM feedback from indoor motor.

STATIC PRESS:

- Static pressure of indoor unit.

SERVICE— LAST 10 SYSTEM EVENTS

This screen will show last 10 events that occurred throughout the system. Each entry has the time and date incident recorded. Service technician should enter current date in “**TODAY’S DATE**” menu section BEFORE checking and logging the last 10 system events.

Each entry has a two-letter acronym preceding the event name to identify which piece of equipment generated the event. This event history can be cleared under Thermostat Setup, Reset Factory Defaults.

HP = Heat Pump

AC = Air Conditioner

FN = Furnace

FC = Fan Coil

SPP = Packaged product

SAM = System Access Module

SERVICE — RUN / FAULT HISTORY

The indoor unit and outdoor unit (if communicating) have the following histories:

NOTE: For Critical Fault Screens, see Troubleshooting section in this document.

RESETTABLE FAULTS:

- Fault counters for each piece of equipment that can be reset.

CYCLE COUNTERS:

- Number of heat/cool/power cycles the unit has performed.

RUN TIMES:

- Lifetime hours of operation in heating, cooling, and how long the unit has been powered.

SERVICE — TODAY’S DATE

This menu item allows the installer to enter the current date. It is used for time/date stamping of system faults. This should be entered every time prior to viewing “LAST 10 SYSTEM EVENTS” section.

SERVICE — MODEL / SERIAL NUMBERS

This menu item allows the installer to view the model number and serial number (if available) of all communicating pieces of equipment in the system.

SERVICE — SERVICE PHONE NUMBER

This menu item allows the installer to enter a name and phone number that the homeowner can call for future service of the system. This name and phone number will appear to the homeowner whenever a service reminder pop-up message is displayed (i.e. Change Filter, etc.)

To edit:

- Use Temp +/- button to move cursor left and right.
- Use Time +/- button to select numbers and letters.
- Use Scroll button to move up and down between NAME and NUMBER.

OPERATIONAL INFORMATION**CONTINUOUS FAN OPERATION**

Pressing FAN button will scroll through the following:

- AUTO = No fan operation except during equipment operation.
- LOW = Approximately 50% of High Speed operation.
- MED = Half way between High and Low speed operation.
- HIGH = Highest of either High Heating or High Cooling CFM.

Continuous fan operation is programmable. The programming option must be enabled in the Thermostat Setup. See the Homeowner’s Manual for detailed instructions on programming the fan.

FIVE-MINUTE COMPRESSOR TIMEGUARD

This timer prevents compressor from starting unless it has been off for at least 5 minutes. It can be defeated by simultaneously pressing the Fan and Temp + buttons.

EMERGENCY HEAT (FOR HEAT PUMP APPLICATIONS)

To activate Emergency Heat, you must press and hold the HEAT button for 3 seconds to activate.

KEYPAD LOCKOUT

Keypad can be locked by pressing “Fan” and “Humidity/Oat” buttons at the same time for 3 seconds. When keys are locked, a lock symbol will appear in the upper left corner of screen. Follow same procedure to unlock keypad.

HEAT AND COOL LED

The Heat and Cool LEDs will pulsate during actual equipment operation.

EQUIPMENT CYCLE TIMER (ADJUSTABLE 4-6 CYCLES PER HOUR)

This timer prevents the start of a heating or cooling cycle until 15 (or 10) minutes after the last start of the same cycle. Its function is to assure that the equipment is not cycled more than the selected times per hour. This timer is adjustable from 4 to 6 cycles per hour. This timer is defeated for one cycle when the desired temperature is manually changed. It can also be defeated for one cycle by simultaneously pressing the Fan and Temp + buttons.

TEN-MINUTE STAGING TIMER

In multistage heating or cooling, this timer prevents any higher stage from turning on until the preceding stage has been on for 10 minutes.

In dual fuel systems, the staging timer is 15 minutes between heat pump and gas furnace operation.

THREE-MINUTE MINIMUM ON TIME

In normal operation, when a stage turns on, it will remain on for a minimum of three minutes. If the set point is changed, this timer is automatically cancelled, allowing the equipment to turn off immediately when the demand is removed.

HEAT/COOL SET POINTS (DESIRED TEMPERATURES)

A minimum difference of 2° (default) is enforced between heating and cooling desired temperatures. This is done by allowing one setting to "push" the other to maintain this difference. This difference is adjustable via the Install/Service menu under Thermostat Setup.

AUTO CHANGEOVER

When Auto mode is enabled (factory default) a change from heat to cool (or vice versa) will not occur until an opposite mode demand has existed for 30 minutes. If the set point is changed, the 30-minute requirement is defeated. This Auto Changeover time is adjustable via the Install/Service menu under Thermostat Setup. Range = 5 - 120 min.

SMART RECOVERY

With Smart Recovery selected (factory default), transition out of setback begins 1.5 hours before selected recovery time and gradually adjusts room temperature so desired temperature will be achieved at selected recovery time. It operates in both heating and cooling. This only applies to programmable operation.

For example: Set back temperature in heating is 64° F. Smart Recovery set point is 70° F at 7:00 a.m. At 5:30 a.m., the control calculates the required temperature recovery rate (recovery temp - set back temp or current temp if greater) / 90 minutes. If the current temp at 5:30 = 66° F, the recovery rate = (70 - 66)°F/90 minutes = 0.04 degrees per minute. In order to achieve set point, the control ramps up the set point 0.04 °F / minute from 5:30 a.m. until 7:00 a.m.

NOTE: Temperatures should not be set back so far that the equipment cannot recover in 90 minutes.

MEDIA FILTER

If **MEDIA** or **MEDIA+EAC** is installed in the indoor unit, the system will perform a static pressure check of the system every 24 hours at 1:00 p.m. to monitor filter accumulation (TrueSense™ Dirty Filter Detection) or whenever power is applied to the system or the system is transitioned from Off to Cool or Heat modes. The blower will run at a medium airflow for one minute.

This system operates by setting a base line static pressure based on the highest airflow the system could run (this could be heat or cool airflow.) The measurement is taken at a low airflow and then calculated up to the highest airflow the system could see.

FROZEN COIL DETECTION

During cooling operation, the user interface will monitor the static pressure of the system. If the static pressure is increasing dramatically, the user interface will turn off cooling for up to one hour, record fault in the "Last 10 Events" screen, and run the fan at a reduced airflow. The user interface will continue to monitor the static pressure. If it is reduced before one hour has elapsed, it will resume cooling operation. After one hour, cooling will be resumed.

DEHUMIDIFY OPERATION

Once a target cooling humidity set point is selected in the Advanced Setup **COOLING HUMIDITY** screen, two other setup options affect Dehumidify operation: **AC AIRFLOW** and **DEHUMIDIFY**.

AC AIRFLOW: This setting is located in the Furnace or Fan Coil Setup screens and must be set to **COMFORT** to enable dehumidify operation. If set to **EFFICIENCY** or **MAXIMUM**, no special dehumidify operation will take place. Cooling will only operate to satisfy the space temperature set point.

DEHUMIDIFY: Located in the Cooling Humidity screen of the Advanced Setup, this option has 2 settings: **ON** and **OFF**.

If **DEHUMIDIFY** is set to **ON** (factory default), and the **AC Airflow** is set to **COMFORT**, then the cooling unit will be allowed to overcool the space up to 3° if the humidity level is above the cooling humidity target set point.

The amount of overcooling allowed varies with the dehumidification demand, the cooling demand, and the actual space temperature. More overcooling is allowed with greater dehumidification demand.

When the space temperature is at or above 75° and the dehumidify demand is high, overcooling up to 3° is allowed. As the space temperature approaches 70°, less overcooling is allowed. At 70° space temperature, no more overcooling is allowed no matter how great the dehumidify demand. This is done to protect the equipment.

If **DEHUMIDIFY** is set to **OFF** and **AC Airflow** is set to **COMFORT**, normal dehumidification mode is enabled. For normal dehumidification, no overcooling is allowed when the cooling humidity is above the target set point, but airflow will be reduced during a normal cooling mode to reduce humidity. The airflow depends on the amount of dehumidify demand. If **AC Airflow** is set to **EFFICIENCY** or **MAXIMUM**, all dehumidification functions are defeated.

DUAL FUEL SETUP / OPERATION

FURNACE LOCKOUT — (in **FURNACE SETUP** menu) is the outside temperature above which the furnace will not run (otherwise known as the aux heat lockout).

HEAT PUMP LOCKOUT — (in **HEAT PUMP SETUP**) is the outside temperature below which the heat pump will not run (otherwise known as the balance point).

These values can be set identical to each other. If they are not identical, the system will stage up and down normally from heat pump to furnace when the outside temperature is between these lockout settings. The user interface will not allow the furnace lockout setting to be above the heat pump lockout setting.

The factory default settings for both of these is **NONE** (no lockouts). Even though a furnace lockout temperature may be set, the system will still use the furnace in defrost operation, and will complete the heating cycle using the furnace after a defrost has finished.

TROUBLESHOOTING

Please refer to the Troubleshooting Guide available on HVAC Partners for more detail.

Infinity Control does not power up.

1. Recheck wiring to ABCD on all devices.
2. Make sure all colors match for every terminal.
3. Make sure power is applied to the indoor unit, and the amber LED is lit on indoor control circuit board.
4. Check for 24VAC between the C and D terminals at Infinity Control terminal connector and Damper Control Module.
5. Check fuse on indoor unit's circuit board.

Display says "Indoor Unit Not Found"

1. Recheck wiring to ABCD on all devices.
2. Make sure all colors match for every terminal.
3. Press left-side button to try again.
4. If display still reads "Indoor Unit Not Found", disconnect all devices from ABCD and connect User Interface directly to indoor unit.

Display says "Outdoor Unit Not Found", and I have a two-stage communicating outdoor unit:

1. Recheck wiring to ABCD connector on outdoor unit.
2. Make sure all colors match for every terminal.
3. Check for 24VAC between the C and D terminal connector of outdoor unit.

I made a mistake on the start-up screens, and hit the right-side button to get to the run mode. How do I get back to start-up?

1. Press the ADVANCED button for at least 10 seconds.
2. Install/Service menu will appear.
3. Scroll down to the INSTALL selection.
4. Press the right-side button; the screen will prompt you to press the right side again to re-install the system.

SYSTEM MALFUNCTION SCREEN



Fig. 28 - System Malfunction Screen

A04028

FAN COIL

Code 37 - Heater output sensed On when not energized

Code 41 - Blower Motor Fault (ventilator, humidifier, dehumidifier, outdoor unit will be turned off)

Code 44 - Motor Communication Fault (ventilator, humidifier, dehumidifier, outdoor unit will be turned off)

Code 45 - Control failure

FURNACE

Code 13 - Limit Circuit Lockout

Code 14 - Ignition Lockout

Code 15 - Blower Motor Lockout (ventilator, humidifier, dehumidifier, outdoor unit will be turned off)

Code 21 - Gas Heating Lockout

Code 22 - Abnormal Flame Proving Signal

Code 23 - Pressure Switch Did Not Open

Code 24 - Secondary Voltage Fuse Open

Code 33 - Limit Circuit Fault AND high heat only is active

Code 41 - Blower Motor Fault (cooling mode only) (ventilator, humidifier, dehumidifier, outdoor unit will be turned off)

Code 45 - Control Circuitry Lockout

NOTE:For codes 13, 14 and 21, the system will use heat pump heating exclusively if available. When the error code is cleared or disappears, furnace heating will resume if still requested.

OUTDOOR UNIT

Code 25 - Invalid model plug

Code 45 - Control Failure

Code 47 - No 230V at unit

Code 73 - Contactor shorted

Code 74 - No high voltage at compressor

Code 76 - Low stage didn't start three times

Code 78 - High stage didn't start three times

Code 81 - Thermal lockout in low stage - 4 hrs.

Code 82 - Thermal lockout in high stage - 4 hrs.

Code 83 - Low Pressure Lockout - 4 hrs.

Code 84 - High Pressure Lockout - 4 hrs.

Code 85 - Low contactor open

Code 86 - Low contactor shorted

Code 87 - High contactor open

USER INTERFACE

- Temp sensor failed, loss of communication with smart sensor, smart sensor fault. "NO SENSOR DATA" shown
- Indoor unit communication fault
- Outdoor unit communication fault
- Packaged product communication fault
- NIM communication fault
- SAM communication fault
- Possible Frozen Coil

The user can press the right side button to dismiss the notice. The regular run mode screen will then appear except "SYSTEM MALFUNCTION" will appear in place of the day/time. If the error has not disappeared within 24 hours, the above display will return. If the error code disappears, "SYSTEM MALFUNCTION" will disappear and the day/time will reappear.

